



SE675

Hand Operated

SE679

Hand & Foot Operated

Installation, Maintenance and Operating Instructions

DESCRIPTION

Floor mounted EMERGENCY DELUGE SHOWER & AERATED EYE WASH combination unit. Shower is supplied with a 25mm stay open full flow ball valve, activated by a triangle pull rod. Eye wash is supplied with a 15mm stay open full flow ball valve, activated by an activation paddle handle and foot pedal. Manufactured by PBA Safety to comply with AS 4775 - 2007

SHOWER

Shower Head: 200mm ABS Cyclocac
Valve: 25mm Stainless Steel
Activator: 304 Stainless Steel Pull Rod
Stanchion: 304 Stainless Steel Frame

EYE/FACE WASH

Eye/Face Wash: Aerated Eyewash
Valve: 15mm Stainless Steel
Activator: 304 Stainless Steel Push Handle
Base Plate: 304 Stainless Steel

INSTALLATION

After unpacking carton, ensure all components are present. Mark out the floor and mount the bottom stanchion section using suitable anchors. Screw in bullhorns & assemble top section (use pipe sealant on all joints). Assemble pull rod and shower head, attach paddle handle and foot pedal (SE679). Once the unit is completely assembled connect water supply to 25mm top inlet nipple. Failure to use potable water can result in emergency units producing impure or contaminated water causing possible further injury. Test unit.

TESTING

The Australian Standards AS4775-2007 states that all safety equipment shall be activated on a weekly basis to flush the line and verify proper operation. All units include a testing tag to be filled out weekly.

NOTE: This unit should be connected to an uninterrupted source of potable water, no less than 25mm with a minimum flowing pressure of 138KPa and a maximum static pressure of 860 KPa.

OPERATION

The shower is activated by pulling the triangle pull rod. Once the valve is activated the head will continue to discharge water until the valve is manually closed, this is done by pushing the pull rod to the off position.



The eye wash is activated by pushing the paddle handle back 90 degrees. The unit will operate until the paddle handle is manually pulled to the off position.

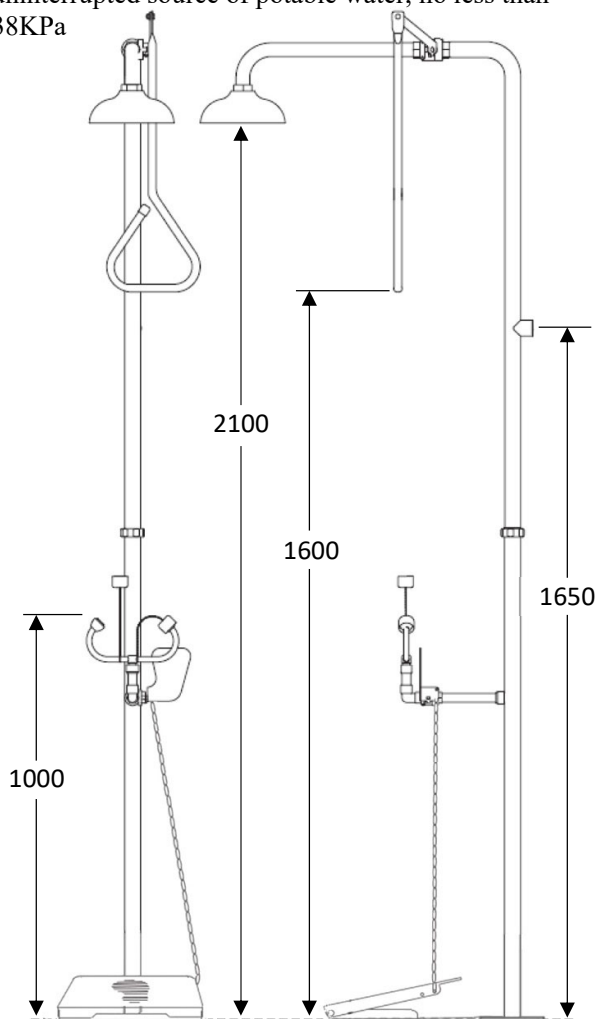
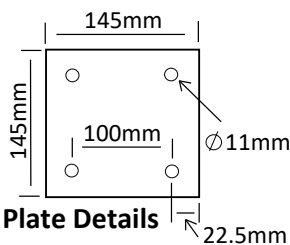
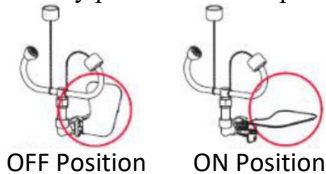

WARNING: Use only genuine Speakman parts when replacing or repairing components.

To order free call 1800 444 022 or free fax 1800 444 024

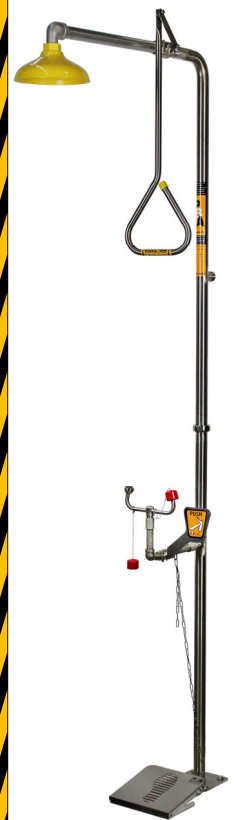

SE679 / SE675
Combination Deluge Shower
& Aerated Eye Wash



Installation, Maintenance and Operating Instructions

MAINTENANCE

Should you need to repair this unit, please see the parts list for correct part numbers. Before any maintenance is done **be sure the water supply is shut off.**

MAINTENANCE SCHEDULE

Activate eyewash unit and allow water

Weekly

to flow for 30 seconds to flush line.

Ensure water flows evenly from both outlets.

Ensure water is clean.

Yearly

Ensure unit complies with AS 4775 – 2007.

- ① **Part No: RPG05-1177**
Aerator Screen & Cap Assembly



- ② **Part No: SA 01003**
Complete Bulls Horns Assembly

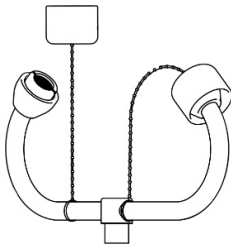

FLOW DATA

Eye Wash

Flow Rate: 12 LPM

Shower

Flow Rate: 78 LPM

SPARE PARTS LIST

No:	Description:	Part No:
1.	Aerator, Screen & Cap Assembly	RPG05-1177
2.	Complete Bull Horns Assembly	SA 01003
3.	Dust Cap Assembly	SA 01008
4.	Pull Rod Assembly	SA 02008
5.	25mm Activation Ball Valve	SE 911
6.	200mm Cyclac Shower Head	SE 810
7.	Combination Frame	SA 03008
8.	15mm Ball Valve & Push Handle	SE 910H-L
9.	Foot Pedal Connection Chain	SA 03014
10.	Foot Pedal Assembly	SA 03001
11.	Shower Arm 25mm BSP	SC 02001

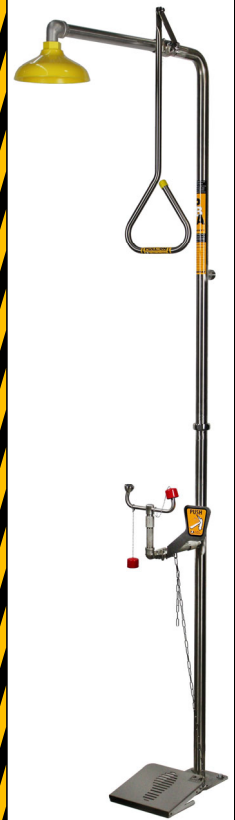
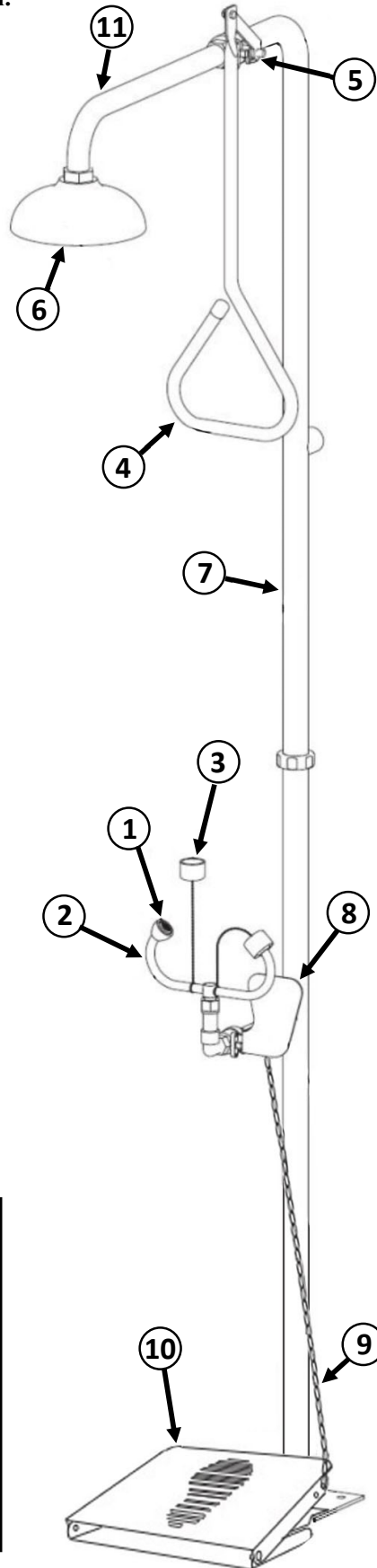

SE679 / SE675
Combination Deluge Shower
& Aerated Eye Wash

WARNING: Use only genuine Speakman parts when replacing or repairing components.

To order free call 1800 444 022 or free fax 1800 444 024